

Excellent Integrated System Limited

Stocking Distributor

Click to view price, real time Inventory, Delivery & Lifecycle Information:

[Molex Connector Corporation](#)
[0559320930](#)

For any questions, you can email us directly:

sales@integrated-circuit.com

10 9 8 7 6 5 4 3 2 1

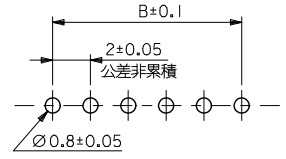
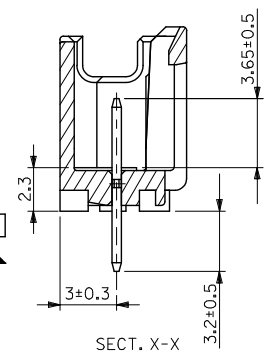
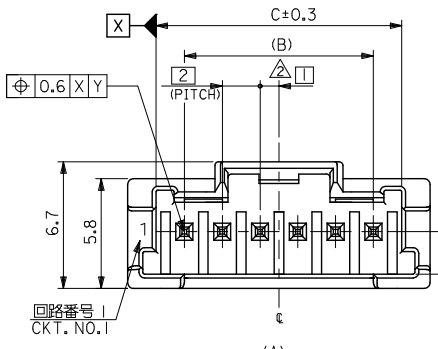

NOTE
 1. 嵌合相手: 51382-****
 2. 偶数種 (列) に適用。
 3. キングは両外側の位置に付加。
 4. 製品番号 MATERIAL NO.
55932-****
 極数 CIRCUIT SIZE
 5. 材質
 ピン : 黄銅
 ハウジング : PBT
 6. めっき
 錫めっき
 下地 : ニッケルめっき

推奨基板寸法
(t = 1.6)

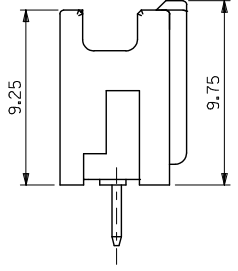
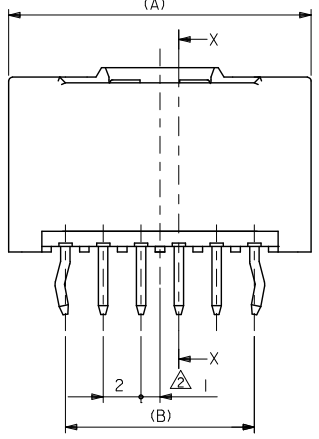

極数 CIRCUIT SIZE	色 COLOR
30	自然色 (白) NATURAL (WHITE)
31	黒 BLACK
32	赤 RED
33	黄 YELLOW
34	青 BLUE
35	桃 PINK
36	緑 GREEN
37	茶 BROWN
38	橙 ORANGE
39	紫 VIOLET
51	灰 GRAY
53	蛍光黄 FLUORESCENT YELLOW
54	水 PALE BLUE
55	蛍光桃 FLUORESCENT PINK
56	黄緑 YELLOWISH GREEN
58	蛍光橙 FLUORESCENT ORANGE

31	28	34	55932-15**	15
29	26	32	55932-14**	14
27	24	30	55932-13**	13
25	22	28	55932-12**	12
23	20	26	55932-11**	11
21	18	24	55932-10**	10
19	16	22	55932-09**	9
17	14	20	55932-08**	8
15	12	18	55932-07**	7
13	10	16	55932-06**	6
11	8	14	55932-05**	5
9	6	12	55932-04**	4
7	4	10	55932-03**	3
5	2	8	55932-02**	2
C	B	A	MATERIAL NO. CKT.	

REVISED EC NO: J2015-0937 DRW: RHMATSUYAMA CHK: KASAKAWA APPR: NIKITA 2015/10/05 2015/10/05 2015/10/26	GENERAL TOLERANCES (UNLESS SPECIFIED)		DIMENSION STYLE		SCALE	DESIGN UNITS METRIC	THIRD ANGLE PROJECTION
	0.25 UNDER ±0.03		MM ONLY		---		
	0.25 OVER 0.5 UNDER ±0.05		DRAWN BY T. NIITSU		DATE '02/02/08	TITLE	
	0.5 OVER 1.0 UNDER ±0.1		CHECKED BY K. ASAKAWA		DATE '03/06/12	2.0 W/B CONN. PLUG HOUSING ASS'Y ST -LEAD FREE-	
	1.0 OVER 10 UNDER ±0.2		APPROVED BY T. YAMAGUCHI		DATE '03/06/12		
10 OVER 30 UNDER ±0.25		MATERIAL NO.		SEE CHART	DOCUMENT NO.	SD-55932-006	
30 OVER ±0.3		DRAFT WHERE APPLICABLE MUST REMAIN WITHIN DIMENSIONS		SIZE A3	THIS DRAWING CONTAINS INFORMATION THAT IS PROPRIETARY TO MOLEX INCORPORATED AND SHOULD NOT BE USED WITHOUT WRITTEN PERMISSION		
ANGULAR ±3 °						SHEET NO.	1 OF 2

9 8 7 6 5 4 3 2 1

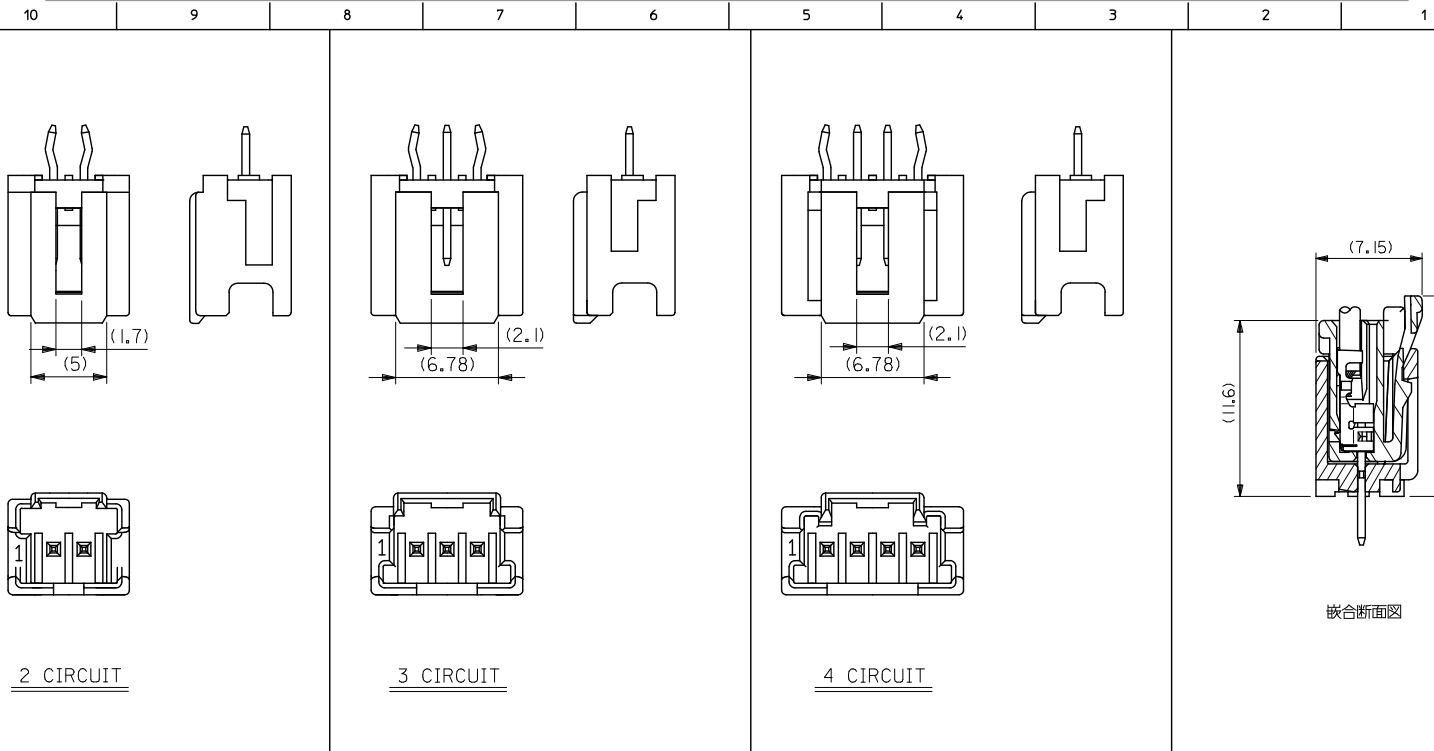

REVISED EC NO. J2015-0937 DRAWN BY MATSUJIMA 2015/10/05 CHIKIDAKAKAWA 2015/10/05 APPR. NIKITA 2015/10/26	GENERAL TOLERANCES (UNLESS SPECIFIED)		DIMENSION STYLE		SCALE	DESIGN UNITS	THIRD ANGLE PROJECTION
	(UNLESS SPECIFIED)		MM ONLY		---	METRIC	
	0.25 UNDER	±0.03	DRAWN BY	DATE	TITLE		
	0.25 OVER	0.5 UNDER	T. NIITSU	'02/02/08	2.0 W/B CONN. PLUG HOUSING ASS'Y ST -LEAD FREE-		
	0.5 OVER	1.0 UNDER	CHECKED BY	DATE	molex		
1.0 OVER	10 UNDER	K. ASAKAWA	'03/06/12	DOCUMENT NO.			
10 OVER	30 UNDER	APPROVED BY	DATE	SD-55932-006			
30 OVER	±0.3	T. YAMAGUCHI	'03/06/12	SHEET NO.			
ANGULAR	±3 °	MATERIAL NO.		2 OF 2			
DRAFT WHERE APPLICABLE MUST REMAIN WITHIN DIMENSIONS			SEE SHEET 1	THIS DRAWING CONTAINS INFORMATION THAT IS PROPRIETARY TO MOLEX INCORPORATED AND SHOULD NOT BE USED WITHOUT WRITTEN PERMISSION			

10 9 8 7 6 5 4 3 2 1

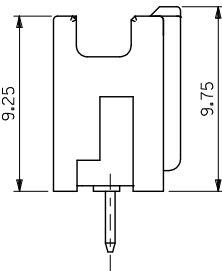
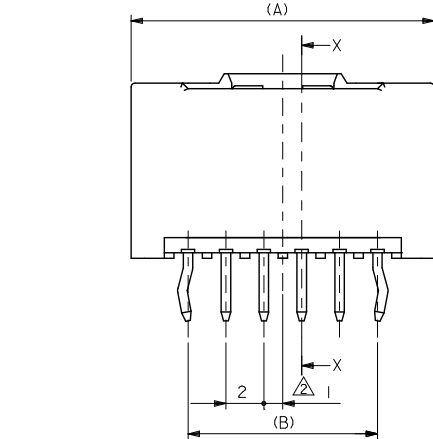
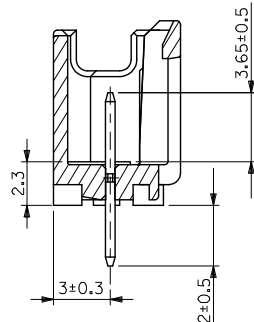
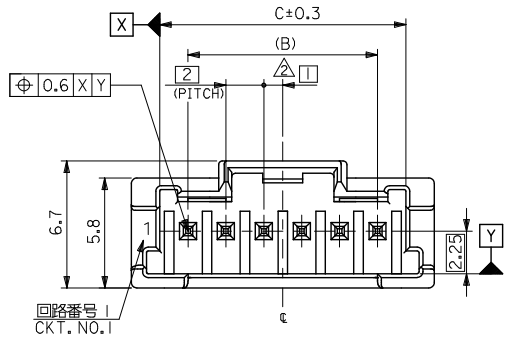

NOTE
 1. 嵌合相手: 51382-****
 2. 偶数極 (列) に適用。
 3. キングは両外側の位置に付加。
 4. ピン: 黄銅, ニッケル下地鍍メッキ
 ハウジング: PBT
 適合リテーナー: 500638シリーズ
 APPLICABLE RETAINER: 500638 SERIES.
 製品番号 MATERIAL NO.
55932-****
 極数 CIRCUIT SIZE

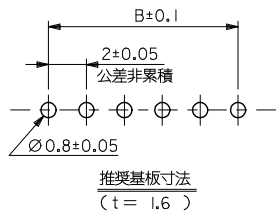

色 COLOR
30 自然色 (白) NATURAL (WHITE)
31 黒 BLACK
32 赤 RED
33 黄 YELLOW
34 青 BLUE
35 桃 PINK
36 緑 GREEN
37 茶 BROWN
38 橙 ORANGE
39 紫 VIOLET
51 灰 GRAY
53 蛍光黄 FLUORESCENT YELLOW
54 水 PALE BLUE
55 蛍光桃 FLUORESCENT PINK
56 黄緑 YELLOWISH GREEN
58 蛍光橙 FLUORESCENT ORANGE

31	28	34	55932-15**	15
29	26	32	55932-14**	14
27	24	30	55932-13**	13
25	22	28	55932-12**	12
23	20	26	55932-11**	11
21	18	24	55932-10**	10
19	16	22	55932-09**	9
17	14	20	55932-08**	8
15	12	18	55932-07**	7
13	10	16	55932-06**	6
11	8	14	55932-05**	5
9	6	12	55932-04**	4
7	4	10	55932-03**	3
5	2	8	55932-02**	2

REVISED EC NO. J2016-0482 DRWN: MIYABE 2015/10/15 CHKD: KAKAWA 2015/11/10 APPR: NUKITA 2015/12/24	GENERAL TOLERANCES (UNLESS SPECIFIED)			MODEL NO.: 55932-****		DIMENSION STYLE MM ONLY		SCALE ---		DESIGN UNITS METRIC		THIRD ANGLE PROJECTION	
	0.25 UNDER	UNDER	±0.03	DRAWN BY YMAEDA		DATE 2005/06/13		TITLE 2.0 W/B CONN.PLUG HOUSING ASS'Y WO BOSS -LEAD FREE-					
	0.25 OVER	0.5 UNDER	±0.05	CHECKED BY MTANAKA		DATE 2005/06/13							
	0.5 OVER	1.0 UNDER	±0.1	APPROVED BY NUKITA		DATE 2005/06/13							
1.0 OVER	10 UNDER	±0.2	MATERIAL NO.		DOCUMENT NO.		SEE CHART		SD-55932-007		SHEET NO. 1 OF 2		
10 OVER	30 UNDER	±0.25	DRAFT WHERE APPLICABLE MUST REMAIN WITHIN DIMENSIONS		SIZE A3		THIS DRAWING CONTAINS INFORMATION THAT IS PROPRIETARY TO MOLEX INCORPORATED AND SHOULD NOT BE USED WITHOUT WRITTEN PERMISSION						
30 OVER		±0.3											

9 8 7 6 5 4 3 2 1

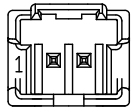
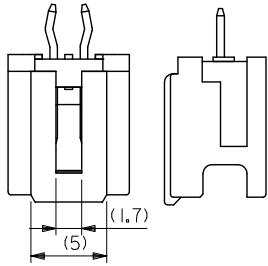

2 CIRCUIT

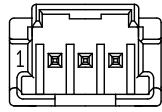
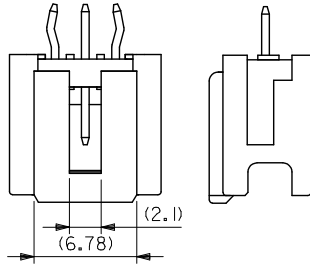

3 CIRCUIT

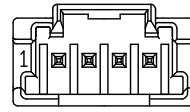
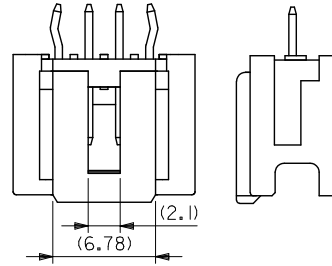

4 CIRCUIT

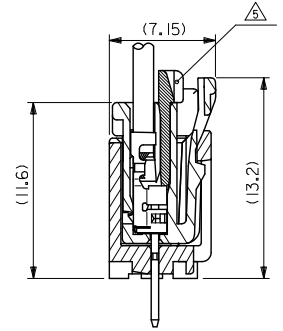

嵌合断面图

REVISED EC NO. J2016-0482 DRAWN: MIYABE 2015/10/13 CHKD: KASAKAWA 2015/11/10 APPR: NUKITA 2015/12/24 REV A	GENERAL TOLERANCES (UNLESS SPECIFIED)			DIMENSION STYLE MM ONLY			SCALE ---	DESIGN UNITS METRIC	MODEL NO.: 55932-**** THIRD ANGLE PROJECTION	
	0.25 UNDER	UNDER	±0.03	DRAWN BY	DATE	TITLE	2.0 W/B CONN.PLUG HOUSING ASS'Y WO BOSS -LEAD FREE- molex DOCUMENT NO. SD-55932-007 SHEET NO. 2 OF 2			
	0.25 OVER	0.5 UNDER	±0.05	YMAEDA	2005/06/13					
	0.5 OVER	1.0 UNDER	±0.1	CHECKED BY	DATE					
	1.0 OVER	10 UNDER	±0.2	MTANAKA	2005/06/13					
10 OVER	30 UNDER	±0.25	APPROVED BY	DATE						
30 OVER		±0.3	NUKITA	2005/06/13						
ANGULAR ±3 °			MATERIAL NO.			SEE SHEET 1				
DRAFT WHERE APPLICABLE MUST REMAIN WITHIN DIMENSIONS						SIZE	THIS DRAWING CONTAINS INFORMATION THAT IS PROPRIETARY TO MOLEX INCORPORATED AND SHOULD NOT BE USED WITHOUT WRITTEN PERMISSION			